

Evaluation of SWAT streamflow components for the Araxisi catchment (Sardinia, Italy)

Maria Grazia Badas^{1*}, Mauro Sulis²,
Roberto Deidda¹, Enrico Piga¹,
Marino Marrocu² and Claudio Paniconi³

1. Dipartimento di Ingegneria del Territorio, Università di Cagliari, Italy.
2. CRS4 (Center for Advanced Studies, Research and Development in Sardinia), Cagliari, Italy
3. INRS-ETE (Institut National de la Recherche Scientifique – Eau, Terre et Environnement), Université du Québec, Canada

Outline

- Aims of the study
- Description of the watershed and dataset
- Baseflow separation
- Yearly calibration
- Daily calibration
- Conclusions

Aim of the study

- Comparison between separation methods (related to response times), and streamflow components provided by the model (obtained from physically based equations)

A reliable simulation of streamflow components is an important step in the adoption of a correct schematization of watershed characteristics

Case study: the Araxisi catchment

- A classification made by the Sardinian Hydrological Survey, designated the basin as **almost impermeable**
- Pre-processing of measured data has suggested that this proposed classification has to be interpreted as absence of water loss to deep aquifer recharge

Overview of the watershed

- Sardinian mountain basin
- Area=125km²
- Average elevation=804 m
- Average steepness=30%
- DEM 100 m
- 41 sub-basins (tr. area=200 ha)

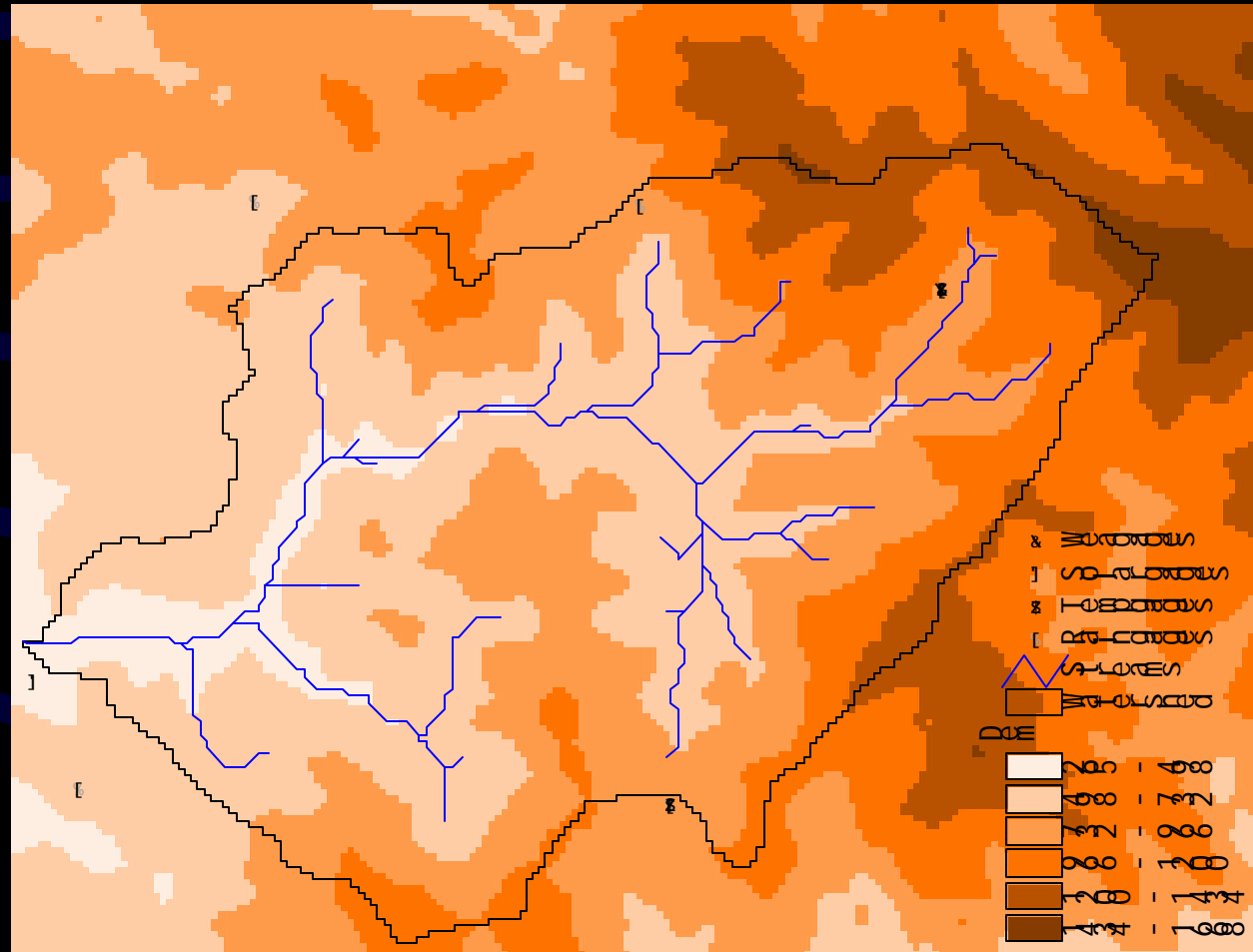

Model Dataset

1946-1975

- daily values of precipitation (5 gages), and maximum and minimum temperatures (2 gages) supplied by the Sardinian Hydrological Survey
- solar radiation daily values from NCEP-NCAR analyses (National Centers for Environmental Prediction and for Atmospheric Research).
- daily discharge values supplied by the Sardinian Hydrological Survey

Land Use Classification

- obtained by a satellite image with a resolution of 400 m

- Prevalent land use classes:

- 36% evergreen forest (FRSE)
- 26% mixed forest (FRST)
- 28% pasture (PAST)

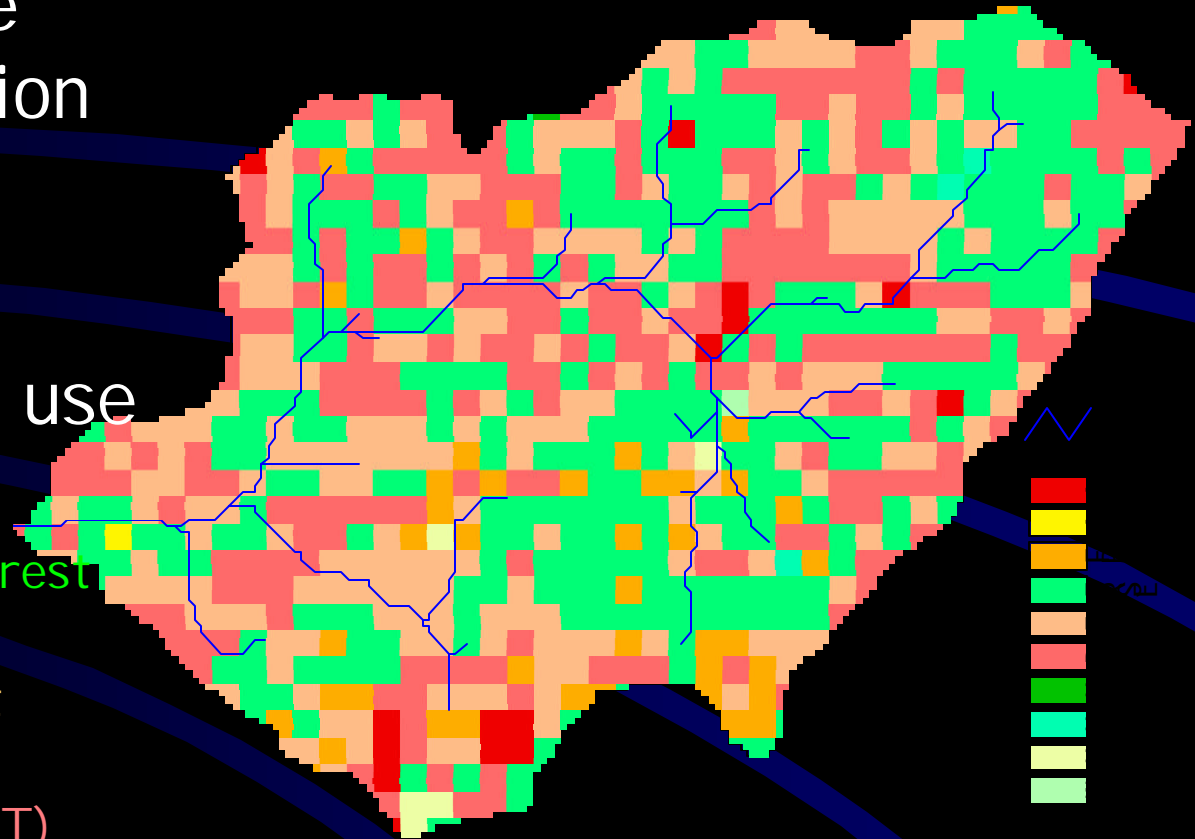

Soil Classification

- lacking of a detailed soil map...
- main soil characteristics for the whole basin:
 - Clay 5%
 - Silt 25%
 - Sand 70%

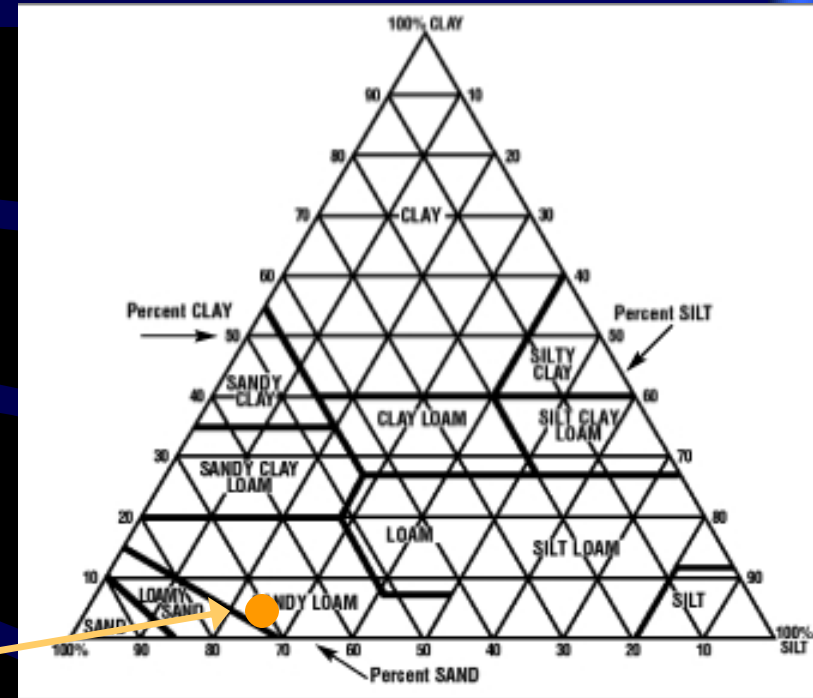

- sandy loam soil (SL) according to the USDA soil texture triangle classification
- soil stratification: two different configurations (single and multiple layers)

STREAMFLOW ASSESSMENT

- hydrograph components: surface runoff, subsurface flow and baseflow
- practically only two streamflow components are recognized: quick flow and recession flow, on the basis of response times, without any reference to the underlying physical processes

Application of two separation techniques to the daily records for baseflow estimation

1. A **classical separation** technique:
 - $Q_b = Q_{tot}$ during interstorm periods;
 - $\log Q_b = \text{linear trend}$ during storm periods
2. A **digital filter** technique
 - proposed by the SWAT developers based on the filtering of **high** and **low** frequency signals (**surface runoff** and **baseflow**)
 - three passes: forward, backward, forward, with a decreasing baseflow rate at each pass [Arnold et al. (1995) and Arnold & Allen 1999]

Comparison of "classical" separation and digital filter technique

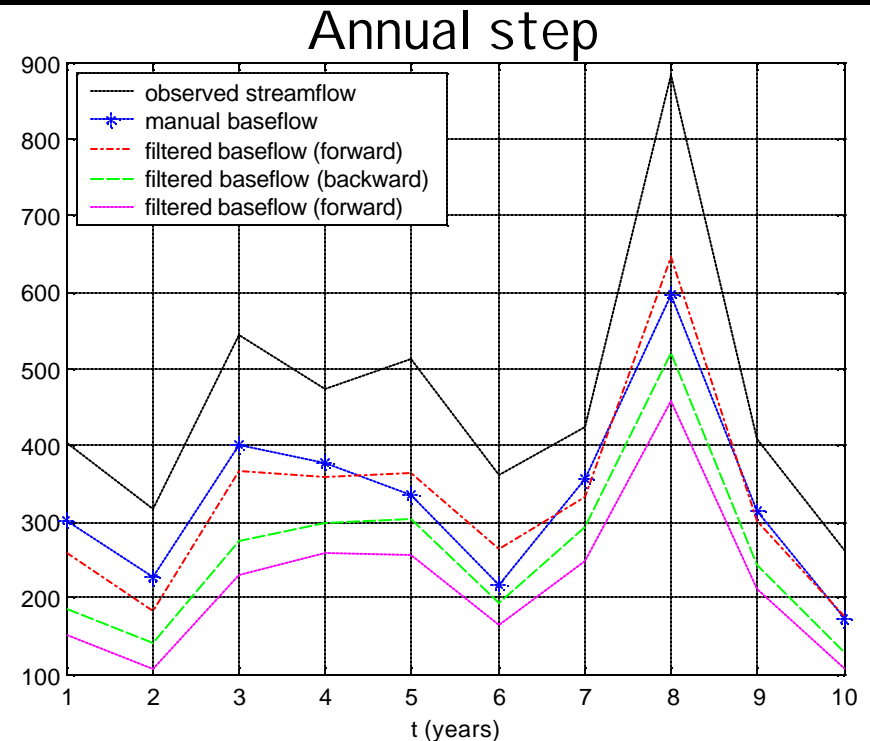
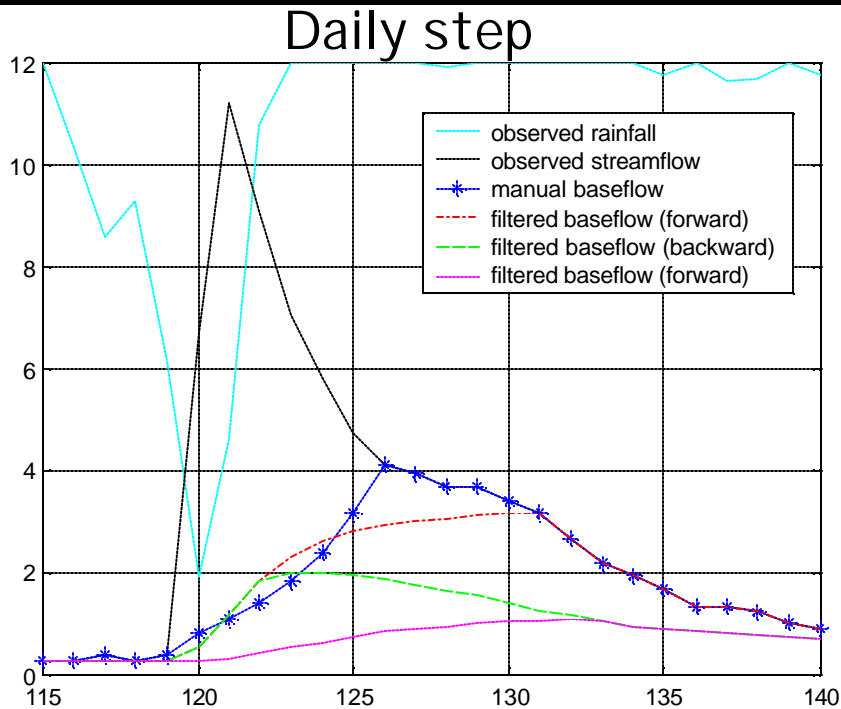

→ the first pass provides results comparable to those of the classical technique **at an annual time step**

Baseflow recession factor (α)

$$Q_t = Q_0 e^{-\alpha t}$$

- Manual technique: α = the average slope of linear trend of logarithmic streamflows within interstorm periods = 0.06 on a sample of 33 manual selected recession periods
- Digital filter method: it considers streamflow separation given by the filter, baseflow recession slopes computed only in low ET months and combined with the Master Recession Curve (MRC) method;
 $\alpha = 0.0143$ calculated on 18 events
→ results are quite different!!

Yearly calibration (1)

(on the first decade of streamflow data)

Many likely sets of parameters were hypothesized, but none of them led to a realistic separation.

EXAMPLE 
(RESULTS FOR ONE SIMULATION)

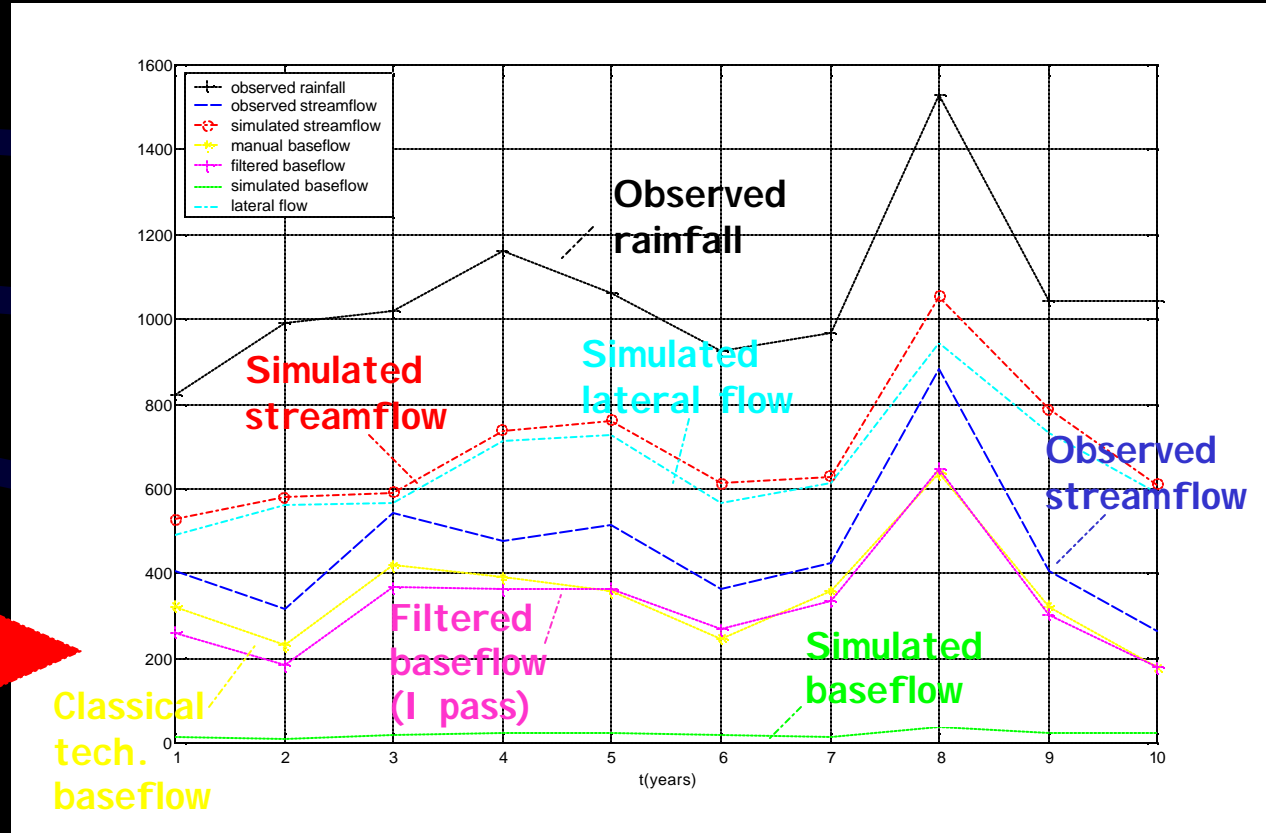

baseflow component practically absent in all the simulations!!!

Yearly calibration (2)

- incorrect calculation of the slope length parameter (L_{hill}) in the AVSWAT interface
- lateral flow (kinematic wave approximation) is in inverse proportion to L_{hill}

- a reliable value is $L_{hill}=50$ m

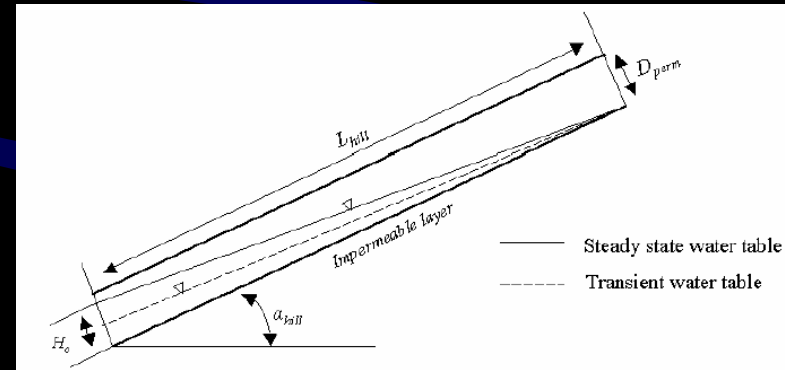

- but the AVSWAT interface fixes $L_{hill}=0.05$ m

- overestimation of the lateral flow
- shortage of available soil water for groundwater recharge

Yearly calibration (3)

Correcting this parameter to 50 m led to a considerable improvement in the streamflow separation

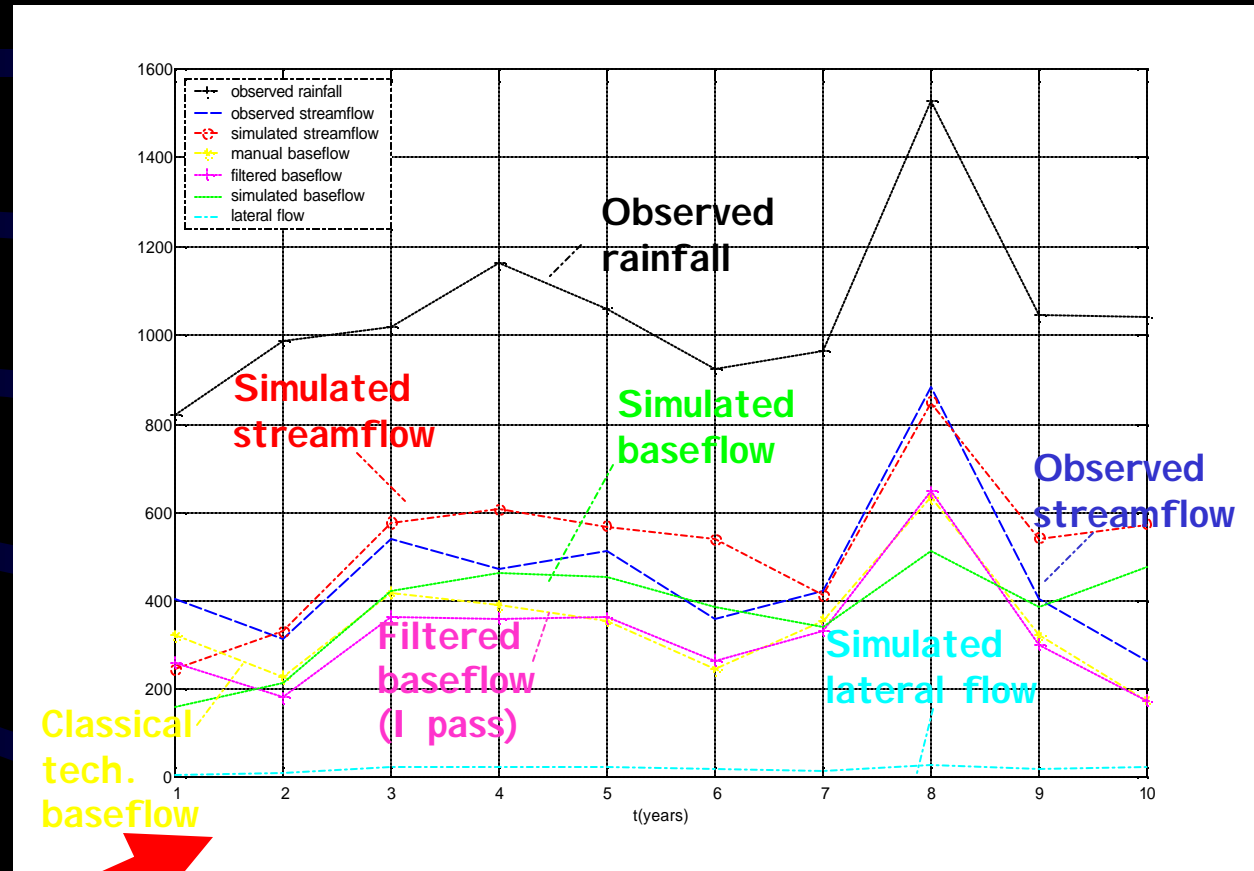

EXAMPLE
(RESULTS FOR ONE SIMULATION)

$L_{\text{hill}} = 50 \text{ m}$

Sensitivity to rainfall data

spatial distribution
of the input rainfall:
an important
influence on the
model response for
a mountain basin

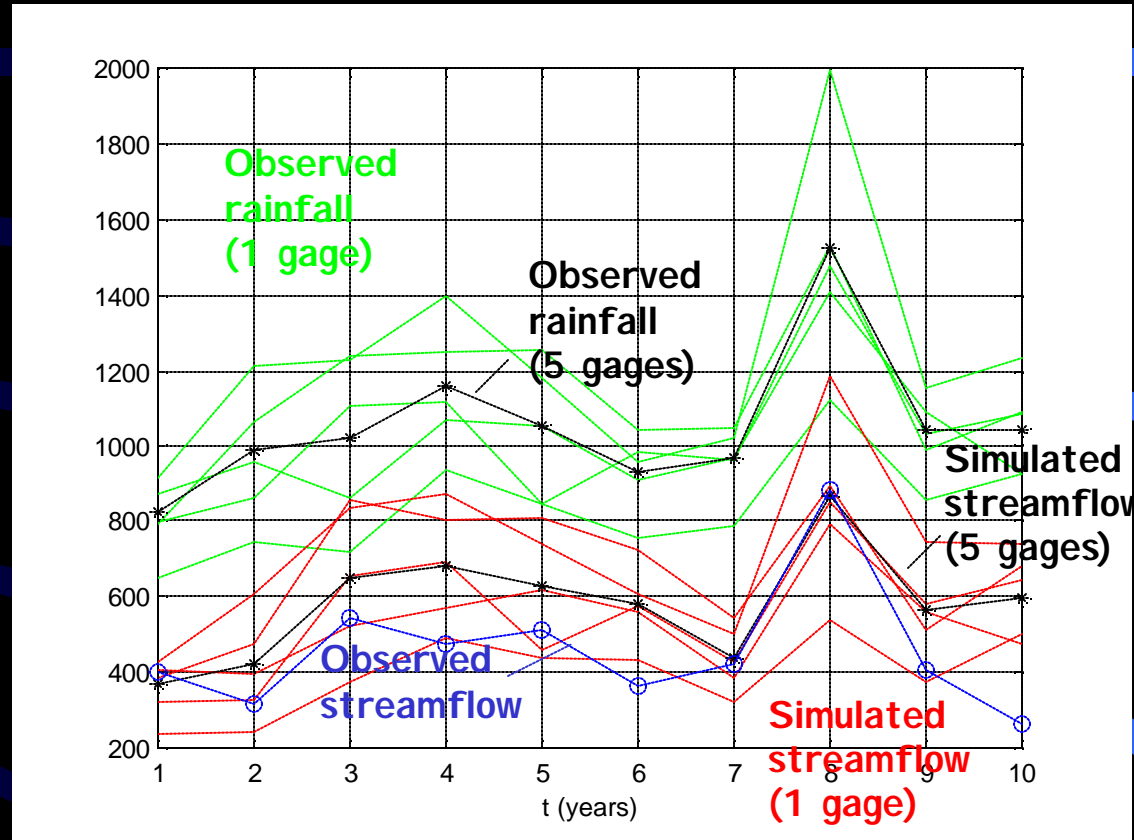

five gages could be unable to correctly
reproduce the actual rainfall patterns

Daily calibration

superimposition of

- spikes during storms
- smooth behaviour during interstorm periods

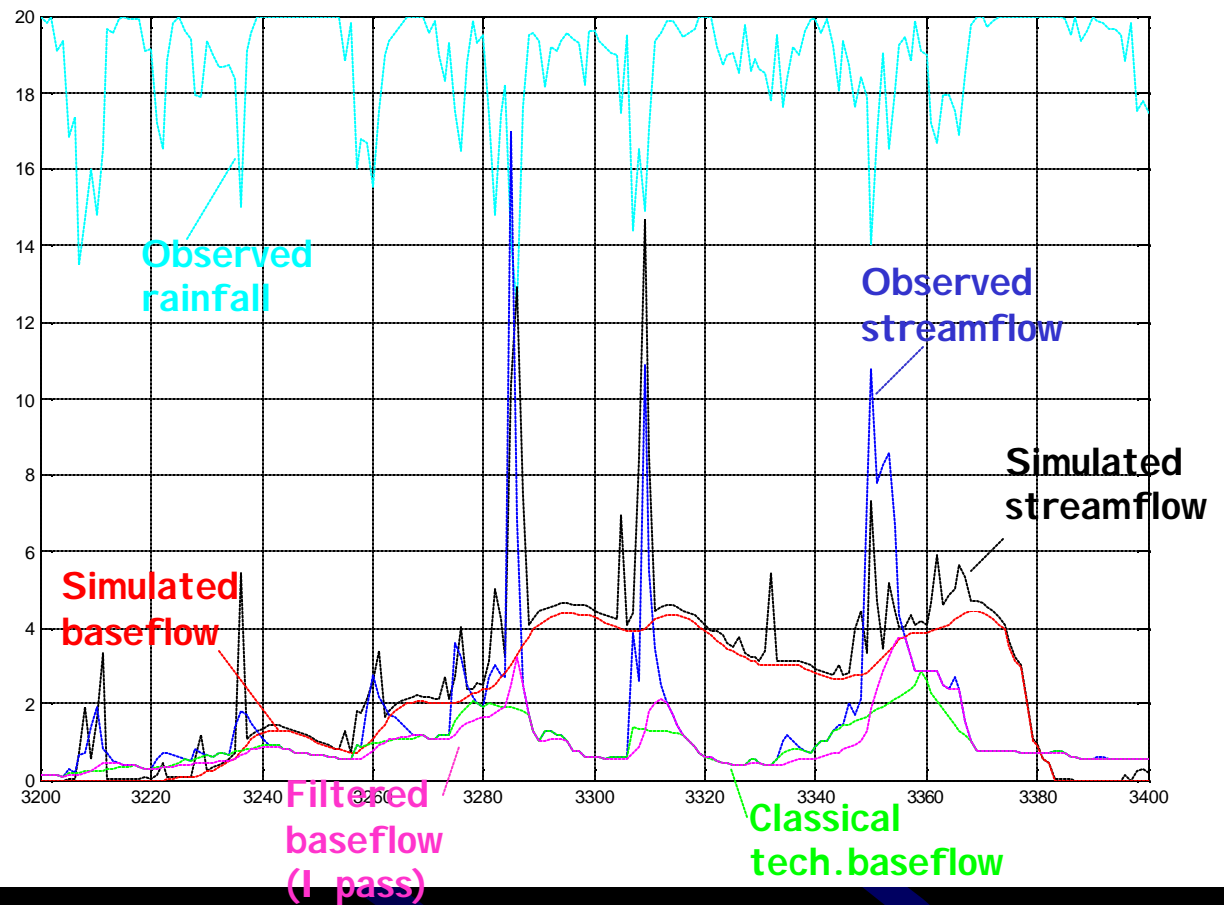

Conclusions and future work

- Comparison between “classical” and digital filter technique
 - Baseflow estimation
 - Baseflow recession factor (α)
- Incorrect calculation of L_{hill} in AVSWAT interface
- Work in progress...
 - Daily calibration
 - Validation of the model
 - Application of other separation techniques